

GEOMETRICAL SHAPES

DIE No: 70202

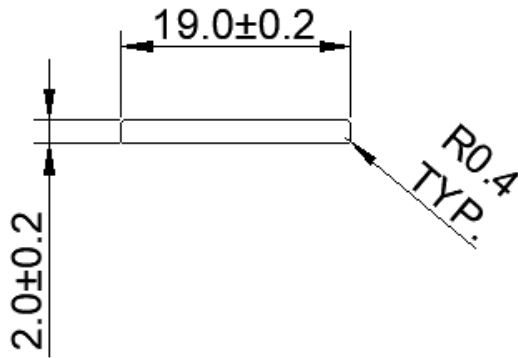

Wt. Range : 0.093-0.114 KG/MTR

DIE No: 70204

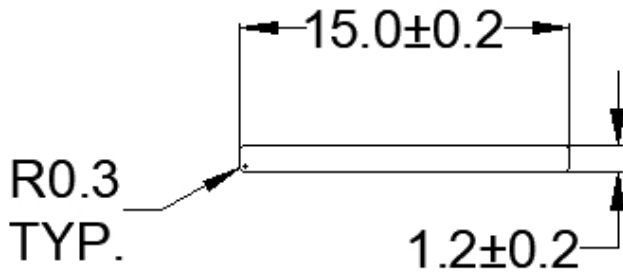

Wt. Range : 0.039-0.057 KG/MTR

DIE No: 70206

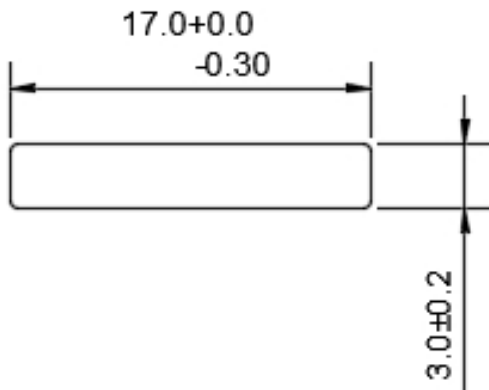

Wt. Range : -

FLAT BAR

DIE No: 70203

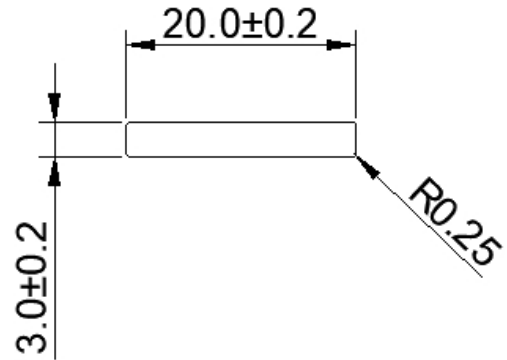

Wt. Range : 0.136-0.187 KG/MTR

DIE No: 70205

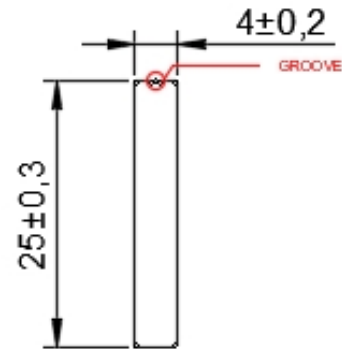

Wt. Range : -

DIE No: 70207

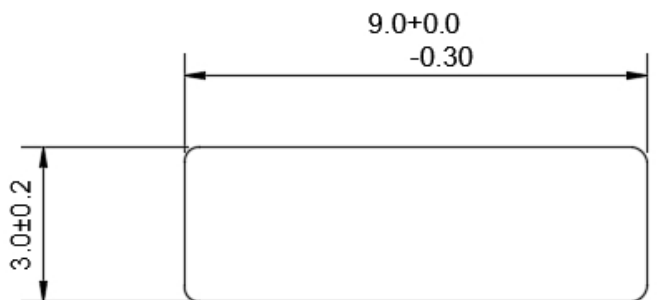

Wt. Range : -

GEOMETRICAL SHAPES

DIE No: 70208

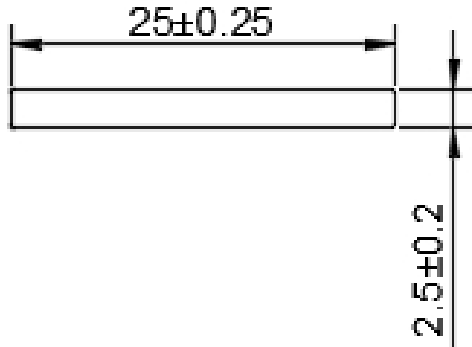

Wt. Range :-

DIE No: 70201

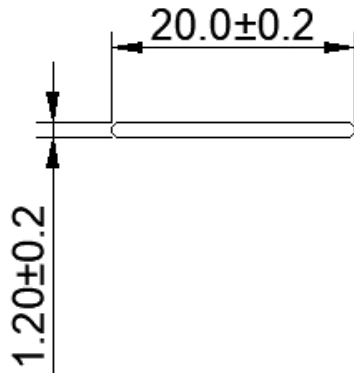

Wt. Range : 0.053-0.075 KG/MTR

DIE No: 70211

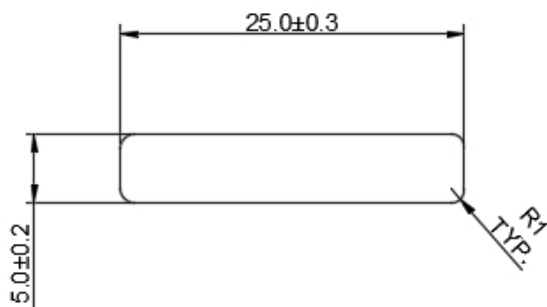

Wt. Range :-

FLAT BAR

DIE No: 70209

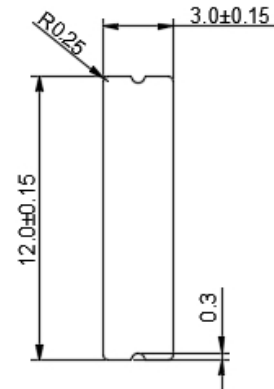

Wt. Range :-

DIE No: 70210

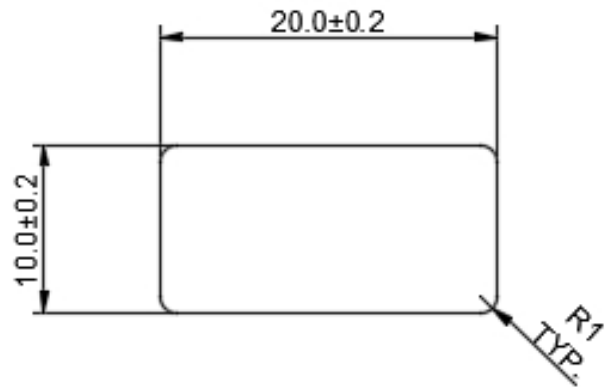

Wt. Range :-

DIE No: 70212

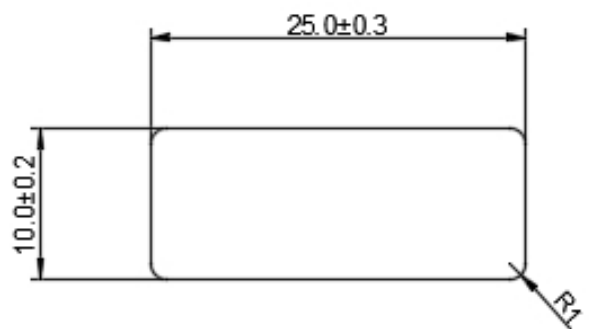

Wt. Range :-

GEOMETRICAL SHAPES

DIE No: 70213

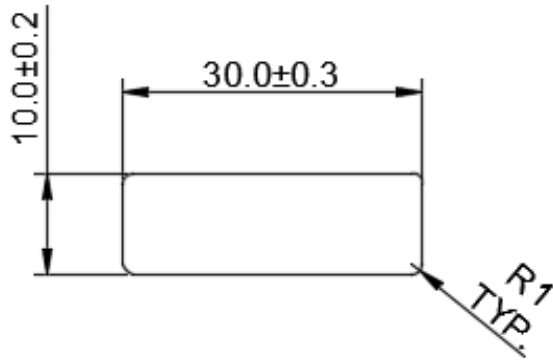

Wt. Range :-

DIE No: 70215

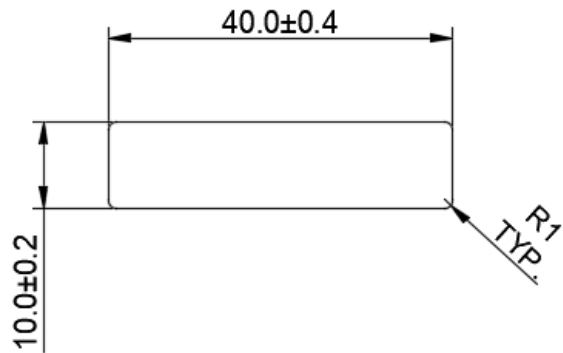

Wt. Range :-

DIE No: 70217

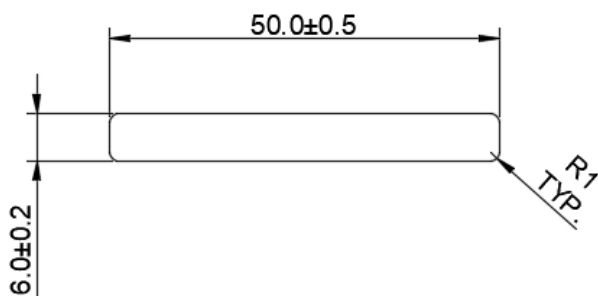

Wt. Range :-

FLAT BAR

DIE No: 70214

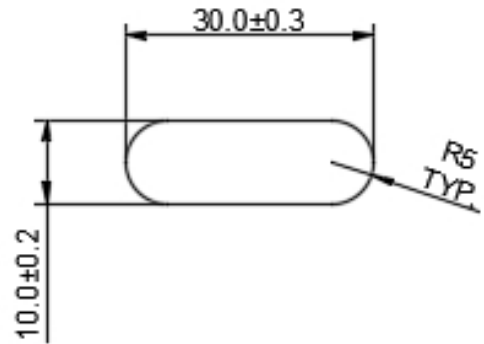

Wt. Range :-

DIE No: 70216

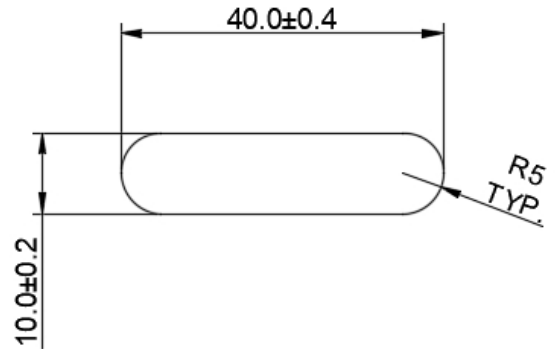

Wt. Range :-

DIE No: 70218

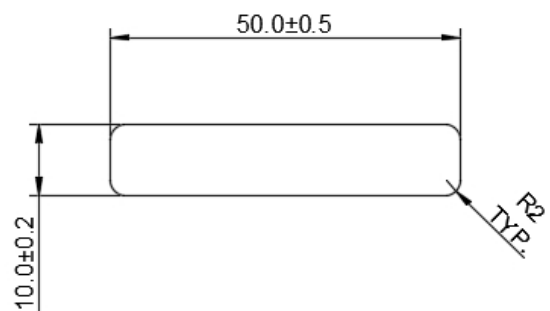

Wt. Range :-

GEOMETRICAL SHAPES

DIE No: 70219

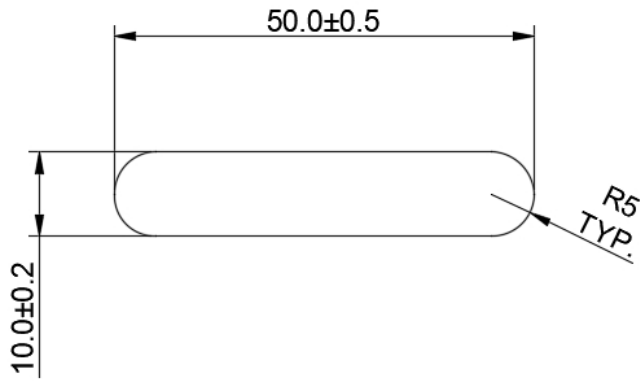

Wt. Range : -

DIE No: 70222

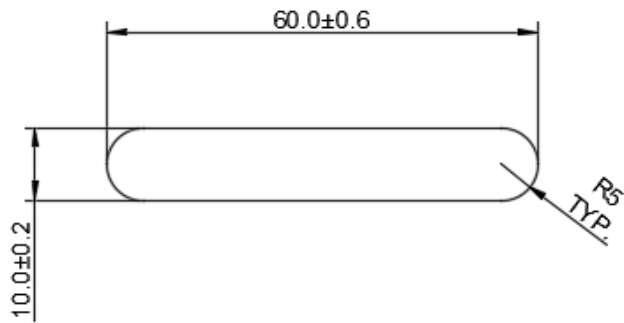

Wt. Range : -

DIE No: 70223

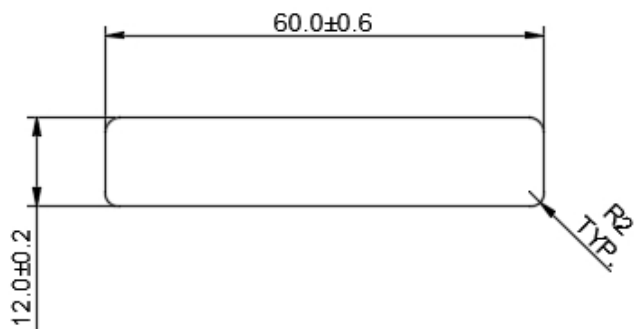

Wt. Range : -

FLAT BAR

DIE No: 70220

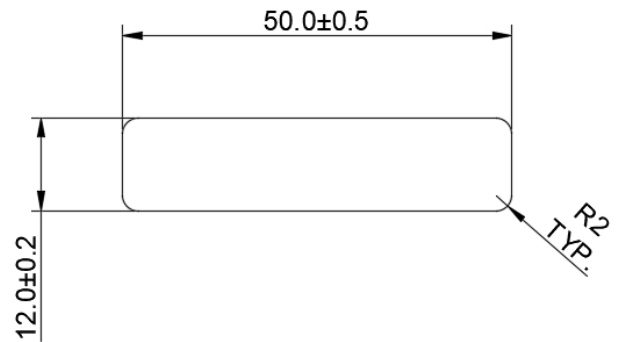

Wt. Range : -

DIE No: 70221

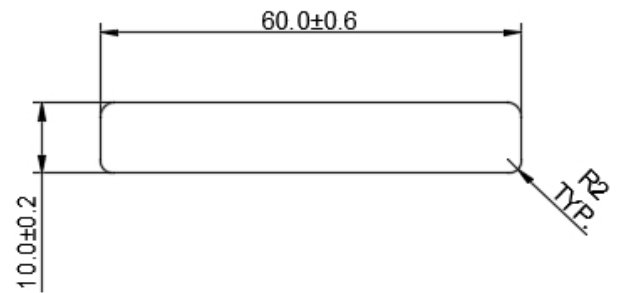

Wt. Range : -

DIE No: 70224

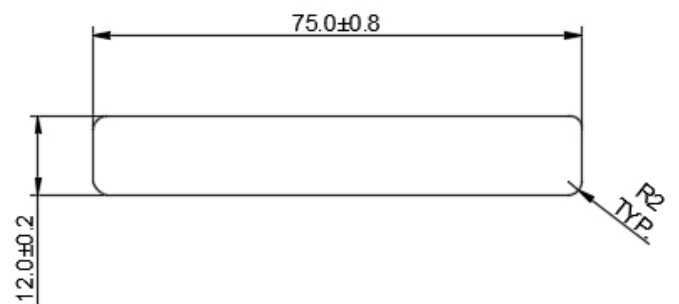

Wt. Range : -

GEOMETRICAL SHAPES

DIE No: 70225

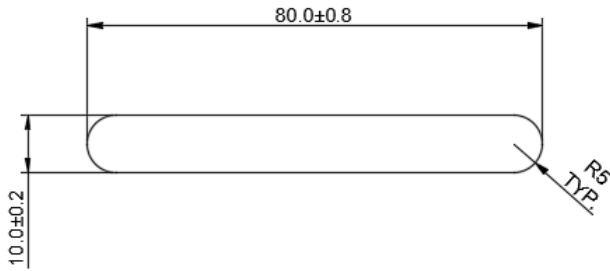

Wt. Range : -

DIE No: 70227

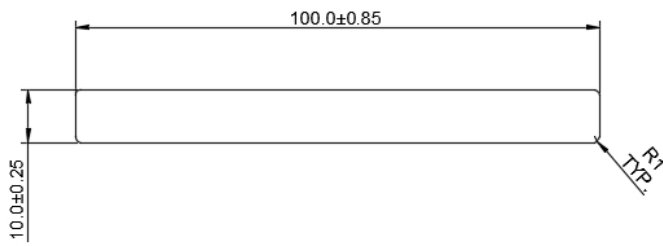

Wt. Range : -

DIE No: 70229

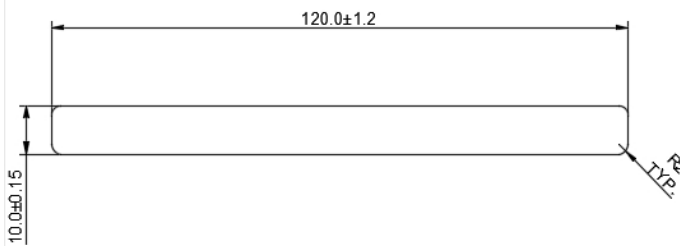

Wt. Range : -

FLAT BAR

DIE No: 70226

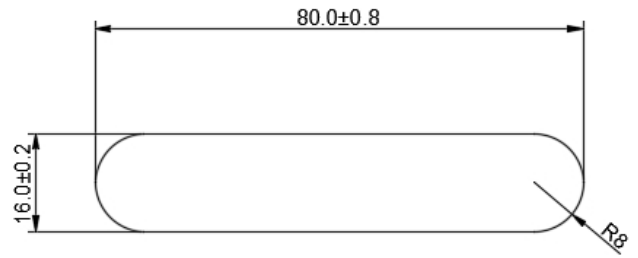

Wt. Range : -

DIE No: 70228

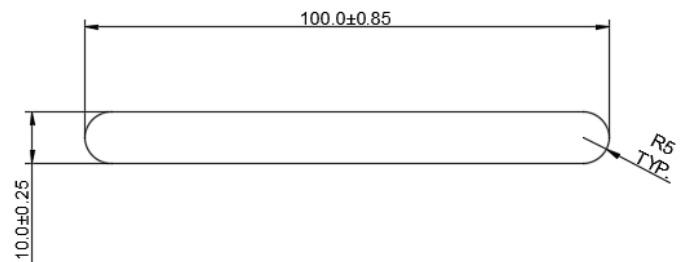

Wt. Range : -

DIE No: 70230

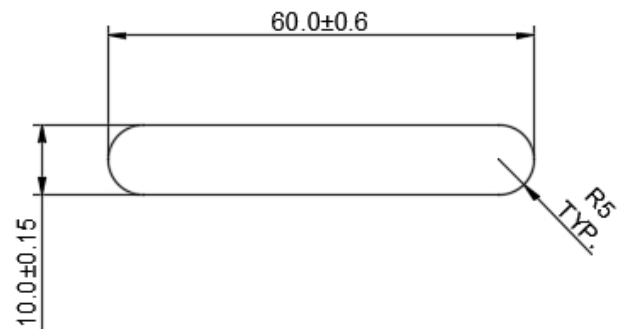

Wt. Range : -